



Chiller Controller Error / Alarm Manual

2900 Samuel Drive | Bensalem, PA 19020
888-289-7299 | 215-638-5515

www.drakechillers.com

TABLE OF CONTENTS

Error Codes with Causes and Solutions:

- Microprocessor Features Page 3
- Water Temperature Sensor Error Page 4
- Compressor Pressure Sensor Error Page 5
- Refrigerant High Pressure Error -H I I Page 6
- Refrigerant Low Pressure Error -L O IP Page 7
- High Water Temperature Alarm Page 8
- Low Water Temperature Alarm Page 9
- Low Water Flow Alarm Page 10
- Location of Fuses, Contactors and Overload Relays Page 11
- Micro Processor Operation, Programming and Settings Page 11-16
- Drake Warranty Page 17
- Micro Processor Diagram Page 18
- PSG Micro Control Board Page 18
- Wiring Locations Page 19

MICROPROCESSOR FEATURES

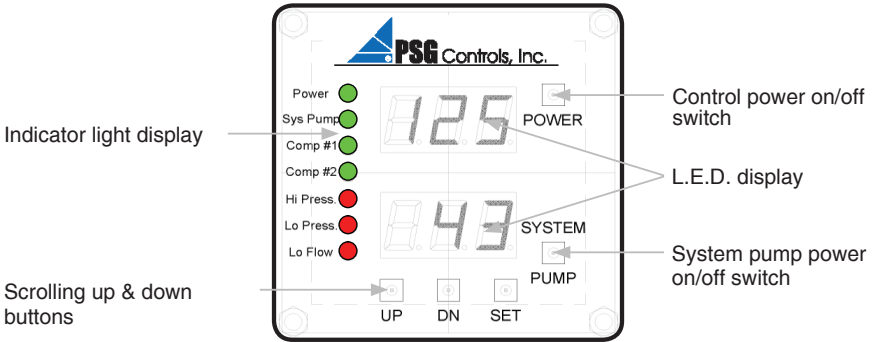

Standard Features

- Control operates to a +/- 1°F accuracy
- Powered from the chiller 24 volt control circuit. No high voltage interference.
- 1 or 2 compressor control capability
- Operates and displays in °F and °C
- Controls chiller on inlet or outlet temperature
- Scroll through set up and review mode
- 30-second compressor time delay to prevent short cycling and nuisance faults
- 60-second hot gas solenoid delay to prevent false hot gas feeding during compressor start up
- Lock out relay shuts down the chiller when control fault settings activate
- Automatic compressor lead lag on dual circuit chillers
- Weather resistant for outdoor use
- Basic chiller functionality for ease of set up and operation
- Factory configured for job site operation
- Factory default function code to reset the controller to the initial factory settings
- Two L.E.D. display windows
 - a) Inlet and outlet temperature during chiller operation
 - b) Displays refrigerant high and low pressure in review mode
 - 1) No cap tubes to break causing a loss of refrigerant and down time
 - 2) No refrigerant recovery to change out the pressure transducer
- Indicator lights
 - a) Chiller control power on/off switch with green indicator
 - b) System pump on/off switch with green indicator
 - c) Compressor run indicator lights
 - d) High and low refrigerant pressure red fault indicator
 - e) Low fluid flow red indicator
- Display flashes all chiller safety faults
 - a) High fluid temperature outlet alarm
Display only - does not shut the chiller down
 - b) Low fluid temperature outlet alarm
Shuts down the chiller and requires manual reset
 - c) High refrigerant pressure
Shuts down the chiller and requires manual reset
 - d) Low refrigerant pressure
Shuts down the chiller and requires manual reset
 - e) Low water flow through evaporator
Shuts down the chiller and automatically resets when flow is restored
- Monitors and logs compressor run hours

1.

Outlet or Inlet Water Temperature Sensor Error



If the temperature sensor transmits an out of range temperature it will be perceived as bad. “Err” will begin flashing in the upper numeric LED while one of the following will be displayed on the bottom numeric LED:

“tSi” for the inlet temperature sensor, and “tSo” for the outlet temperature sensor. The control will de-energize the compressors and hot gas valves and the alarm relay will energize. The re-circulation pump remains energized. The fault is cleared by momentarily pressing the “Power” button on the microprocessor after the error has been resolved. The fault is not cleared by turning off and on the power disconnect switch. (Power disconnect breaker)

Possible Cause:

- 1) Terminal plug is not securely fastened to the controller board
- 2) Loose wire on the terminal plug
- 3) Defective sensor

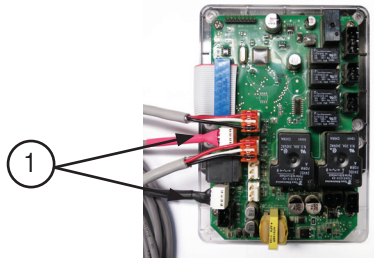

Solution: (with the disconnect off)

- 1) Secure the terminal plug to the controller board
- 2) Push the loose wire into the terminal plug
- 3) Replace the sensor
 - A) Inlet sensor Drake part number D80-303
 - B) Outlet sensor Drake part number D80-304
- 4) Replace the Microprocessor Drake part number D80-344

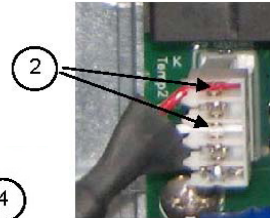

2.

Compressor Pressure Sensor Error



If the voltage received from the pressure sensor's is $< .4\text{vdc}$ or $> 4.6\text{vdc}$ the pressure sensor will be perceived as bad since it's normal operating parameters are $.5\text{vdc}$ to 4.5vdc . "Err" will begin flashing in the upper numeric LED while one of the following will be displayed on the bottom numeric LED: "tL1" for compressor 1 low pressure sensor, "tL2" for compressor 2 low pressure sensor, "tH1" for compressor 1 high pressure sensor, and "tH2" for compressor 2 high pressure sensor. The compressor and hot gas valve will be de-energized and the alarm relay will energize. The fault is cleared by momentarily pressing the "Power" button on the microprocessor after the error has been resolved. The fault is not cleared by turning off and on the power disconnect switch. (Power disconnect breaker)

Possible Cause:

- 1) Transducer harness plug is not securely fastened to the transducer body
- 2) Loose cable wire on the terminal block of the controller
- 3) Voltage to the Chiller is too low / too high
- 4) Defective transducer
- 5) Defective cable harness
- 6) Defective microprocessor

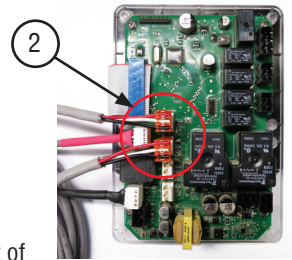
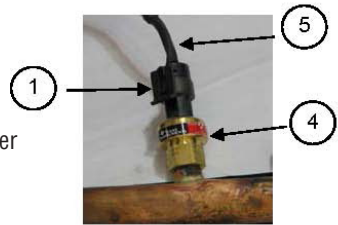

Solution: (with the disconnect off)

- 1) Secure the cable harness plug to the transducer
- 2) Tighten the loose wire into the terminal plug
- 3) Check the line voltage and the transformer secondary and correct if necessary
 - A) Line voltage should be $208\text{-}230\text{V} \pm 10\%$ If out of range this will effect transformer output.
 - B) Control circuit transformer output should be $24\text{V} \pm 10\%$ (See page 8 for location) Drake part number D59-198
- 4) Replace
 - A) HP transducer Drake part number D80-275
 - B) LP transducer Drake part number D80-276
- 5) Replace the Cable harness Drake part number D59-369
- 6) Replace the microprocessor Drake part number D80-344

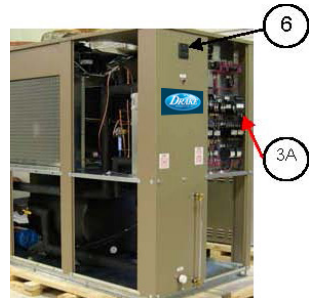

3.

Refrigerant High Pressure Error



If the outlet pressure exceeds the high pressure set point the “Hi Pres” led will illuminate and the “Hi Pres” alarm parameter name will begin flashing in the upper numeric LED. The compressor and hot gas valve will be de-energized and the alarm relay will energize. The parameter value will be displayed in the lower numeric LED. The fault is cleared by momentarily pressing the “Power” button on the microprocessor after the error has been resolved. The fault is not cleared by turning off and on the power disconnect switch. (Power disconnect breaker)

Possible Cause:

- 1) Blocked or dirty condenser coil
- 2) Defective fan motor
- 3) Poor installation location (overhang, other equipment installed too close, Wall, fence or other object is within 3’ of the chiller blocking air flow)
- 4) Refrigerant overcharge
- 5) Microprocessor is translating the incorrect system pressure

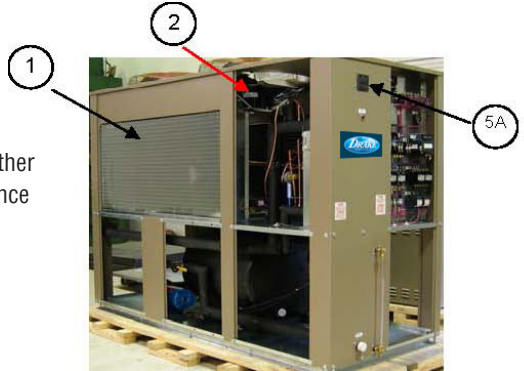

Solution: (with the disconnect off)

- 1) Clean all debris off of the condenser coil
- 2) Replace the fan motor Drake part number D30-051
- 3) Relocate the chiller or other objects to be free from the obstruction
- 4) Have a service technician remove and re-weigh the refrigerant into the system
- 5) Replace:
 - A) Microprocessor Drake part number D80-344
 - B) HP transducer Drake part number D80-275
 - C) Cable harness Drake part number D59-369

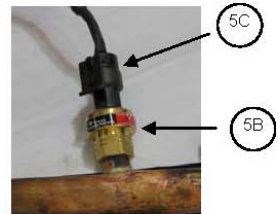

4.

Refrigerant Low Pressure Error



If the outlet pressure is less than the low pressure set point for more than 120 seconds, the “Lo Press” red LED will illuminate and the alarm parameter name will begin flashing on the upper numeric LED. The compressor will be de-energized and the alarm relay will energize. The parameter’s value will be displayed in the lower numeric LED. The “Lo Press” alarm parameter name will continue to flash. The fault is cleared by momentarily pressing the “Power” button on the microprocessor after the error has been resolved. The fault is not cleared by turning off and on the power disconnect switch. (Power disconnect breaker)

Possible Cause:

- 1) Controller set points are incorrect
- 2) Blocked or dirty chiller strainer
- 3) Defective TX Valve
- 4) Refrigerant undercharge
- 5) Chiller pump is not running or is reverse rotation
- 6) Microprocessor is translating the incorrect system pressure
- 7) Receiver heater is not working

- A) Heater fuse Drake part number D53-058
- B) Heater control Drake part number D80-264

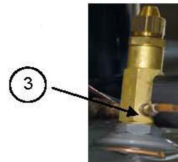

Solution: (with the disconnect off)

- 1) Reset the control set points to the factory specification
- 2) Clean the chiller strainer
- 3) Have a service technician adjust or replace the TX valve Drake part number D80-110
- 4) Have a service technician electronic leak check the chiller and repair if necessary, then remove and re-weigh the refrigerant into the system
- 5) Check Pump operation and impeller rotation
- 6) Replace:
 - A) Microprocessor Drake part number D80-344
 - B) LP transducer Drake part number D80-276
 - C) Cable harness Drake part number D59-369

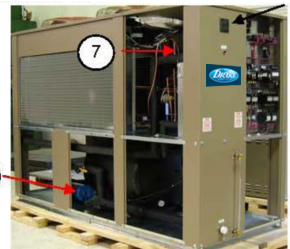

7) Replace:



5.

High Water Temperature Alarm

.....



High water temperature exceeds the set point for 10 seconds the “**Hi Temp**” LED will illuminate and the “**Hi Temp**” alarm parameter name will flash on the upper numeric LED, but the control will continue to function normally.

The alarm relay is not affected by the High Temperature alarm and does not energize. The parameter value will be displayed in the lower numeric LED. When the outlet water temperature recovers to below the set point the “**Hi Temp**” LED will turn off. Normal run display will resume.

Possible Cause:

- 1) Controller set points are incorrect
- 2) Chiller is tripped on another fault

Solution:

- 1) Reset the control set points to the factory specification
- 2) Determine which fault the chiller is off on by the red indicator light on the left side of the controller. Go to the page with the corresponding fault and follow the possible cause

6.

Low Water Temperature Alarm

.....



If the outlet water temperature is less than the set point the “**Lo Temp**” LED will illuminate and the “**Lo Temp**” alarm parameter name will flash on the upper numeric LED. The compressor will be de-energized and the alarm relay energizes. The parameter value will be displayed in the lower numeric LED. When the outlet water temperature recovers to above the set point the “**Lo Temp**” LED will illuminate steadily. The fault is cleared by momentarily pressing the “Power” switch after the temperature is greater than the reset point. Once cleared the control will attempt to function normally. It will not reset automatically.

Possible Cause:

- 1) Controller set points are incorrect
- 2) Defective Microprocessor

Solution: (with the disconnect off)

- 1) Reset the control set points to the factory specification
- 2) Replace the microprocessor Drake part number D80-344
- 3) Replace the temperature sensors Drake part number D80-303 & D80-304



7.

Low Water Flow Alarm



Water Flow: If the water flow drops below the point required to keep the flow switch closed, the “**Lo Flow**” alarm parameter name will flash on both numeric LED’s and the control will de-energize the compressors and hot gas valves. The re-circulation pump remains energized. It will reset automatically.

Possible Cause:

- 1) Pump is not running
- 2) Flow switch is out of adjustment
- 3) Air in the flow switch lines
- 4) Defective flow switch
- 5) Blocked or dirty chiller strainer
- 6) Loose wire connection
- 7) Defective microprocessor relay

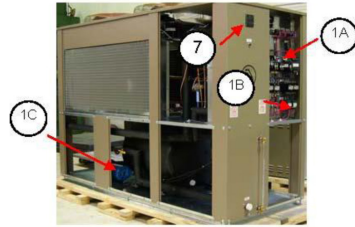

Solution: (with the disconnect off)

- 1) Check and replace:
 - A) Fuse Drake part number D53-008
 - B) Overload Relay Drake part number D50-057
 - C) Pump Drake part number D35-XXX
- 2) Adjust the flow switch to the proper setting
- 3) Bleed the air out of each 1/4” copper line at the switch
- 4) Replace the flow switch Drake part number D80-210 (New models D80-340)
- 5) Clean the chiller strainer
- 6) Tighten the wire connections on the control board and inside the flow switch
- 7) Replace the microprocessor. Drake part number D80-344

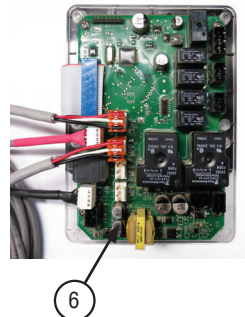
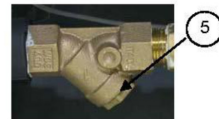
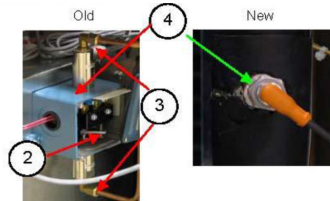

Controller Settings								
dEG	CP	Tc	SP1	dF1	HP1	LP1	HtA	Lta
F	1	OUT	65	2	375	30	80	50
F	1	OUT	65	2	375	30	80	50

Changing the factory chiller set points will result in non-warranty service calls. Lowering the SP1 setting could result in nuisance low pressure trip.

This document explain the functionality of the Drake Chiller Controller and Drake Remote Display Unit Version 7.60 07/2013

This control is powered by 24 VAC and provides control of up to two compressors by monitoring water temperature and line pressure. Compressor control is accomplished via switching 24 VAC to the motor contactor. Run time control parameters are user programmable and, once set and saved, are maintained in non-volatile memory. Please refer to the programming section for more information on this topic. An optional remote display will be available which provides remote display of system parameters.

DRAKE CHILLER CONTROLLER OPERATION:

Mains power switch is closed:

- Mains power is applied to the controller system transformer (24 VAC). The controller’s power supply is now energized and power is supplied to the pressure transmitters but all pumps and compressors remains off until the power switch on the panel is pressed. The control indicators have 3 reds dots illuminated in each display.

Power On: Power switch on control is pressed and held for 5 seconds (Normal operation):

- All the control LED’s briefly flash as an indicator test, then the digital displays and the power indicator will illuminate. Any previous alarms are cleared. The top numeric LED will indicate the inlet water temperature and the lower numeric LED will indicate the outlet water temperature. If the control has not been configured the letters “**CFG**” will appear on the upper 3-digit LED (This is a factory only function).
- The re-circulation pump is energized. There is no status LED for this pump. Any time the power is on, the re-circulation pump is on.
- If the inlet water temperature is above either setpoint plus differential, cooling will be called. After the compressor delay (30 seconds, fixed) the first compressor will energize. The “**Compressor 1**” green LED illuminates.
- Hot gas relay valves will all be energized 60 seconds after the compressor starts. Should the setpoints be set such that both compressors could be energized at the same time, a short delay will be imposed on the second compressor to reduce power line inrush to the chiller.

- If so equipped, the secondary compressor will energize based on the second setpoint and differential. The same delays outlined for compressor #1 will be observed. To equalize compressor run time, periodically the primary and secondary compressor assignments will switch. The LED will illuminate for the actual compressor in use. Should the setpoints be set such that both compressors could be energized at the same time, a short delay will be imposed on the second compressor to reduce power line inrush to the chiller.
- Once the setpoint is achieved or surpassed the compressor will be de-energized. The hot gas relay will also de-energize but the re-circulation pump will remain energized. The compressor will be available for another call immediately, but will not engage until after the compressor delay time expires.
- When the inlet water setpoint plus differential is again exceeded, the compressor will again energize per the schedule listed above and the cycle will repeat. The compressors are rated for continuous duty and will run continuously if required.

System Pump Control: Momentarily pressing the “**pump**” switch energizes the system pump relay. The “**PUMP**” LED illuminates. Momentarily pressing it again turns it off. **Power Off:** Press and hold the power switch. After holding the power switch for 5 seconds the compressor(s), the hot gas relays and the re-circulation pump will de-energize. The system pump will also de-energize. All control LED’s will turn off and the control will be off except all (and only) the decimal points on the numeric LED’s will be on. The pressure transducers will remain powered. The mains disconnect must be used to completely remove control power.

ALARM CONDITIONS AND INDICATIONS:

- **Temperature Sensor:** If the temperature sensor transmits an out of range temperature it will be perceived as bad. “**Err**” will begin flashing in the upper numeric LED while one of the following will be displayed on the bottom numeric LED: “**tSi**” for the inlet temperature sensor, and “**tSo**” for the outlet temperature sensor. The Drake Control Manual V740 Page 1 of 5 control will de-energize the compressors and hot gas valves and the alarm relay will energize. The re-circulation pump remains energized. The fault is cleared by momentarily pressing the “**Power**” switch after the error has been resolved. It will not reset automatically.
- **Pressure Sensor:** If the voltage received from the pressure sensor(s) is < .4vdc or > 4.6vdc the pressure sensor will be perceived as bad since it’s normal operating parameters are .5vdc to 4.5vdc. “**Err**” will begin flashing in the upper numeric LED while one of the following will be displayed on the bottom numeric LED: “**tL1**” for compressor 1 low pressure sensor, “**tL2**” for compressor 2 low pressure sensor, “**tH1**” for compressor 1 high pressure sensor, and “**tH2**” for compressor 2 high pressure sensor. The compressor and hot gas valve will be de-energized and the alarm relay will energize. The fault is cleared by momentarily pressing the “**Power**” switch after the error has been resolved. **It will not reset automatically.**

• **High Temperature:** If the outlet water temperature exceeds the setpoint for 10 seconds the “**Hi Temp**” LED will illuminate and the “**Hi Temp**” alarm parameter name will flash on the upper numeric LED, but the control will continue to function normally. The alarm relay is not affected by the High Temperature alarm and does not energize. The parameter name value will be displayed in the lower numeric LED. When the outlet water temperature recovers to below the setpoint the “**Hi Temp**” LED will turn off. **Normal run display will resume.**

• **Low Temperature:** If the outlet water temperature is less than the setpoint the “**Lo Temp**” LED will illuminate and the “**Lo Temp**” alarm parameter name will flash on the upper numeric LED. The compressor will be de-energized and the alarm relay energizes. The parameter value will be displayed in the lower numeric LED. When the outlet water temperature recovers to above the set point the “**Lo Temp**” LED will illuminate steadily. The fault is cleared by momentarily pressing the “**Power**” switch after the temperature is greater than the reset point. Once cleared the control will attempt to function normally. **It will not reset automatically.**

• **Water Flow:** If the water flow drops below the point required to keep the flow switch closed, the “**Lo Flow**” alarm parameter name will flash on both numeric LED’s and the control will de-energize the compressors and hot gas valves. The re-circulation pump remains energized. **It will reset automatically.**

Review Mode: A review (read only) mode is available which will display the program variables and settings. The control will continue to run normally during the review mode. To access review mode press the set button. Then use the UP or DN key to step through each parameter. There are six (6) additional parameters viewable; “**Hi1**”, “**Hi2**”, “**Lo1**”, “**Lo2**” (actual pressure readings) which appear first in the list, and “**Hr1**” and “**Hr2**” (compressor hours) which appear after the “**LtA**” setpoint. There is no “**Upd**” function in review mode. To exit the Review mode, momentarily press the “**Set**” key. There is no timeout to automatically exit the review mode. **Note: In the event of an alarm the Review mode will terminate and the control and alarm settings will be active.**

Programming: Press and hold both the “**UP**” and “**DN**” switches for 3 seconds to enter programming mode from the run mode. Control will continue to operate while changes are made using the existing parameters. The parameter name will be displayed on the upper numeric LED and the parameter value will be displayed on the lower numeric LED. Use the UP/DN keys to change the value, use the “**Set**” to keep that value and advance to the next parameter. The last parameter is “**Upd**”, which will save the settings to memory and make them the active the control parameters when the “**Set**” key is pressed. This also exits the programming mode. If no keys are pressed after 30 seconds in any programming display, the programming mode is aborted and any changes are discarded. The following are the parameters and the order of display: Drake Control Manual V740 Page 2 of 5 “**dEG**” degrees F or degrees C “**tc**” Select whether inlet or outlet temperature control (limits: in or out) “**SP1**” temperature setpoint for compressor 1 (limits: -40 to +120) “**SP2**” temperature setpoint for compressor 2 (limits: -40 to +120) (requires dual compressor model) “**df1**” temperature differential #1 (limits: 1 to 10) “**df2**” temperature differential #2 (limits: 1 to 10) (requires dual compressor model) “**HP1**” high pressure setpoint #1 (limits: 200 to 490 psi) “**HP2**” high pressure setpoint for compressor 2 (limits: 200 to 490 psi)...

(requires dual compressor model) “**LP1**” low pressure setpoint #1 (limits: 1 to 100 psi) “**LP2**” low pressure setpoint for compressor 2 (limits: 1 to 100 psi) (requires dual compressor model) “**HtA**” high temperature outlet water alarm (limits: max setpoint + max differential +2) “**LtA**” low temperature outlet water alarm (limits: min setpoint – 2) “**Upd**” update settings to permanent memory, exit programming mode to active mode.

Note: In the event of an alarm the programming mode will terminate and the control and alarm settings will be active. Any new settings will be discarded.

Initial Setup (factory setup):

Press and hold the “**UP**” and “**PUMP**” switches for more 3 seconds to enter factory mode from the run mode or setup mode. If the control is unconfigured this mode will appear automatically and the factory default configuration will be loaded.

- The upper display shows “**CFG**”. Press the “**Set**” key and the configuration menu will begin. The name of the parameter being set will appear in the top LED and the value will appear in the lower LED. Use the “**UP**” and “**DN**” keys to change the value to the desired setting. Once at the desired setting, press the “**Set**” key to move to the next parameter. Repeat the sequence to set all parameters. There are extra parameters in the factory menu. The last parameter is “**Upd**”, which will save the changes when the “**Set**” key is again pressed. Due to the nature of the possible changes, there is no timeout from this mode. The values will be saved and the control will begin operation using the new parameters after a few seconds.

These are the parameters:

“**dEG**” degrees F or degrees C “**CP-**” number of compressors, 1 or 2 “**tC**” Select whether inlet or outlet temperature control (limits: in or out) “**SP1**” Temperature setpoint #1 (limits: -40 to +120) “**SP2**” Temperature setpoint #2 (limits: -40 to +120) (requires dual compressor model) “**dF1**” Temperature differential #1 (limits: 1 to 10) “**dF2**” Temperature differential #2 (limits: 1 to 10) (requires dual compressor model) “**HP1**” high pressure setpoint #1 (limits: 200 to 490 psi) “**HP2**” high pressure setpoint for compressor 2 (limits: 200 to 490 psi) (requires dual compressor model) “**LP1**” low pressure setpoint #1 (limits: 1 to 100 psi) “**LP2**” low pressure setpoint for compressor 2 (limits: 1 to 100 psi) (requires dual compressor model) “**HtA**” high temperature outlet water alarm (limits: max setpoint + max differential +2) “**LtA**” low temperature outlet water alarm (limits: min setpoint – 2) “**Hr1**” compressor 1 hours (in 100 hr increments), either keep value or reset to zero (toggle) “**Hr2**” compressor 2 hours (in 100 hr increments), either keep value or reset to zero (toggle, requires dual compressor model) “**Upd**” update settings to permanent memory, exit programming mode to active mode.

Note: Due to the nature of the changes possible in the factory mode, the control is taken off line while in this mode.

INITIAL PROGRAMMING OF THE REMOTE DISPLAY UNIT:

• For initial programming of the remote display unit, you must have first set up the Drake chiller controller as above and then have connected the two through a cat 5 patch cable. Power on the Drake chiller controller then must be turned on, which in turn will turn the remote display unit on. Enter into factory setup mode on the remote display unit by holding “UP” and “PUMP” for more than 3 seconds. You will now have to enter the correct password to enter into factory setup mode. You will see “PAS” on the top display and “000” on the bottom display. The password is “290”. By pressing the “UP” or “DN” key you will see the first digit on the left increment or decrement. When you are at the desired number, press the set key. A degree symbol will now replace the number you have just entered. You may now enter the second digit from the left, then press set, then the third and set. If you have entered the correct password, you will now be in factory setup mode. If not, “BAD” “PAS” will be displayed and the unit will go back to run mode. To try again you must reenter into factory setup mode. The table below shows the parameters that you will be able to access at this point. The 15th parameter (“rdu”) is only available in factory setup mode of the remote display unit. All other parameters are the same as the chiller controllers.

dEG	degrees F or degrees C
CP-	number of compressors, 1 or 2
tC	Select whether inlet or outlet temperature control (limits: in or out)
SP1	Temperature setpoint #1 (limits: -40 to +120)
SP2	Temperature setpoint #2 (limits: -40 to +120) (requires dual compressor model)
dF1	Temperature differential #1 (limits: 1 to 10)
dF2	Temperature differential #2 (limits: 1 to 10) (requires dual compressor model)
HP1	high pressure setpoint #1 (limits: 200 to 490 psi)
HP2	high pressure setpoint for compressor 2 (limits: 200 to 490 psi) (requires dual compressor model)
LP1	low pressure setpoint #1 (limits: 1 to 100 psi)
LP2	low pressure setpoint for compressor 2 (limits: 1 to 100 psi) (requires dual compressor model)
HtA	high temperature outlet water alarm (limits: max setpoint + max differential +2)
LtA	low temperature outlet water alarm (limits: min setpoint – 2)
Hr1	compressor 1 hours (in 100 hr increments), either keep value or reset to zero (toggle)
Hr2	compressor 2 hours (in 100 hr increments), either keep value or reset to zero (toggle, requires dual compressor model)
rdu	Remote display unit – “Std” or “Opt” (“Std” is default)
Upd	update settings to permanent memory, exit programming mode to active mode.

RDU - Std Mode:

- only enter factory setup if you are authorized and know the password
- entering setup mode is disabled
- power button's only function is when momentarily pressed during an error to clear the error on both units
- set button is used to place the remote unit in/out review mode
- up button is used to silence the buzzer for 10 minutes while in an alarm.
- system pump button is disabled

RDU - Opt Mode:

- only enter factory setup if you are authorized and know the password
- entering setup mode is enabled
- power button is used to power on/off the remote unit and the chiller controller, also when momentarily pressed during an error it will clear the error on both units
- set button is used to place the remote unit in/out review mode
- up button is used to silence the buzzer for 10 minutes while in an alarm.
- system pump button is enabled and will turn the system pump on/off on the chiller controller

Note: While the drake chiller controller is in normal operating run mode, the remote display unit will display whatever the controller is displaying as well as turn on/off whatever led's are on, on the drake chiller controller.

Review Mode:

- While the drake chiller controller is in normal run mode (no alarms, not in setup) a review mode is available which will display the program variables and settings of the drake chiller controller. The control will continue to run normally during the review mode. Use the UP or DN key to step through each parameter. To exit the Review mode, momentarily press the "Set" key. There is no timeout to automatically exit the review mode.

Note: In the event of an alarm the Review mode will terminate and the control and alarm settings will be active.

Offline Mode:

- In the event that the drake remote display unit has power, but is not receiving serial information from the drake chiller controller, it will display "OFF" on the top display and "Lne" on the bottom display. This indicates that the chiller controller has power, but is not communicating to the remote. More then likely a wiring issue.

Alarms:

- Alarms are shown exactly as they are shown on the chiller controller. The remote display unit will also sound a buzzer at 50% duration while the alarm is active. If during this time the “up” key is pressed, the buzzer will be silenced for 10 minutes while still in the same alarm. If another different alarm occurs within those 10 minutes then the buzzer would sound again. If after 10 minutes of silence the error still exists the buzzer will sound again. If applicable to the particular alarm, momentarily pressing the power key will clear the error and silence the buzzer. Alarm relay on the drake remote display unit will function the same as the drake chiller controller.

Parts Warranty

Drake Refrigeration Inc.

Factory Startup & Warranty Program
2900 Samuel Drive • Bensalem, PA 19020

Philadelphia Factory: Phone **(888) 289-7299**
Fax: (215) 638-5518

Micro Processor

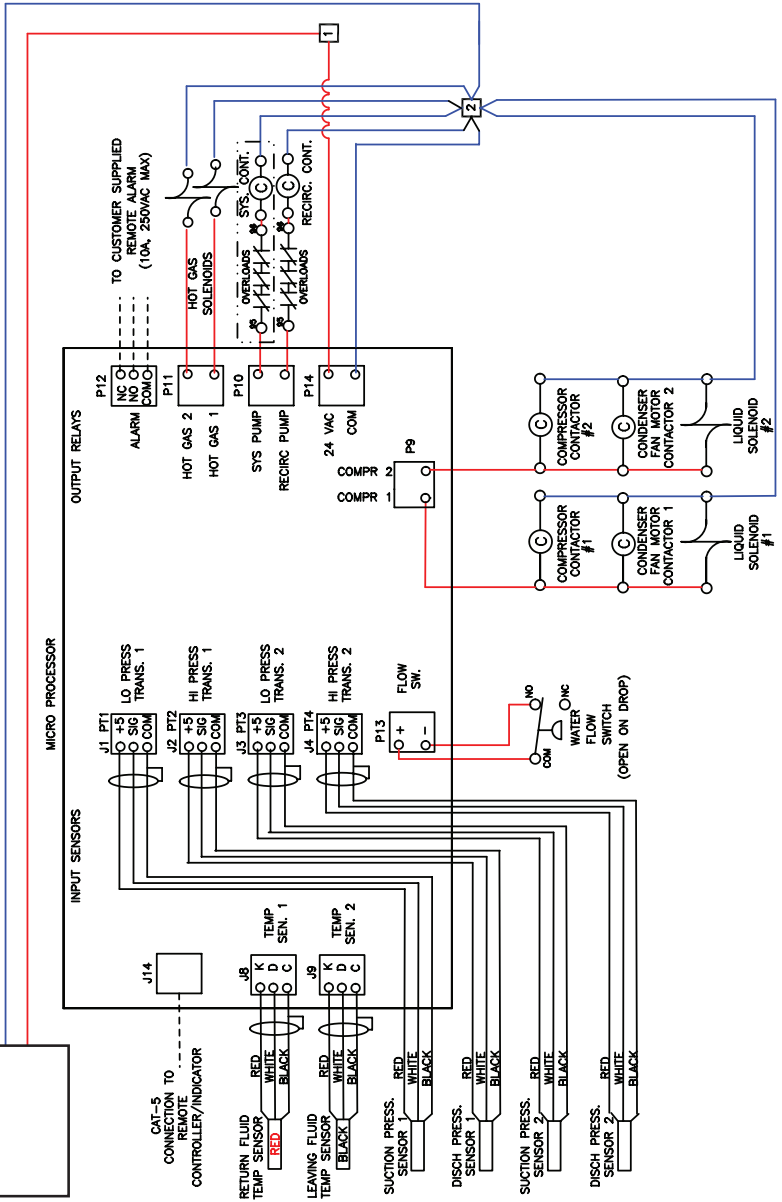
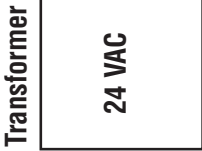

Wiring Locations for the PSG MICRO Control Board

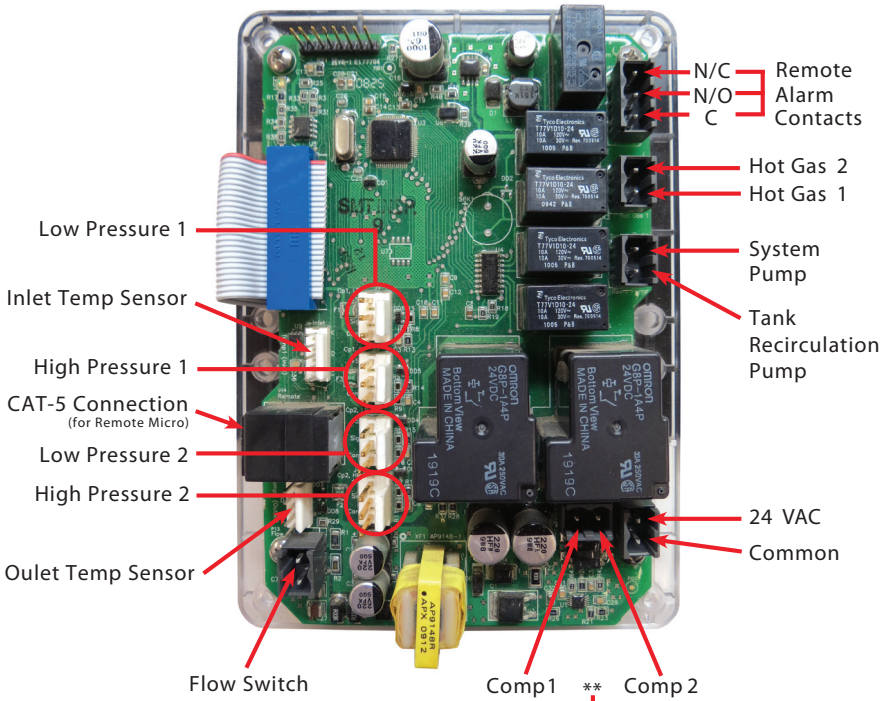

**Older models of this microprocessor may have an earth ground at the compressor output which is no longer necessary with the new models.



2900 Samuel Drive | Bensalem, PA 19020
888-289-7299 | 215-638-5515

www.drakechillers.com

